

REF. 10027

REF. 10113

REF. 10493

REF. 11296

Lock with reversible latch and single throw deadbolt, with 4 or 5 pins cylinder, stainless steel or aluminium front plate.

Serrure avec pêne lançant réversible et pêne dormant de un tour, avec cylindre de 4 ou 5 pistons, têtes en acier inoxydable ou aluminium.

REF.	CYLINDER TYPE TYPE CYLINDRE		FRONT PLATE TÊTIÈRE
	4 PINS 4 PISTONS	5 PINS 5 PISTONS	
XXXX.1		•	Stainless Steel Acier Anoxydable
XXXX.2	•		Aluminium Aluminium
XXXX.31		•	Aluminium Aluminium

45  
un



L

A

REF.	A	B
10113.X	21	36
10027.X	25	40
10493.X	30	45
11296.X	35	50

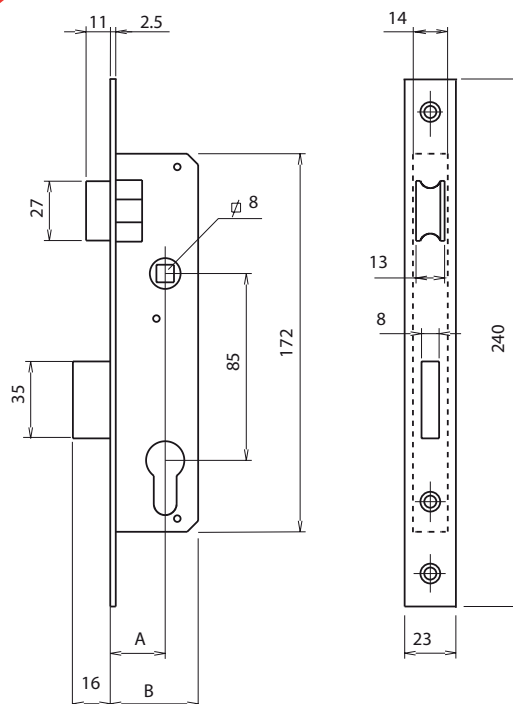

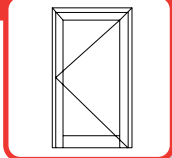

**WEDGES**  
**GÂCHES**

**REF. 7874/2**  
Stainless Steel  
Acier Anoxydable

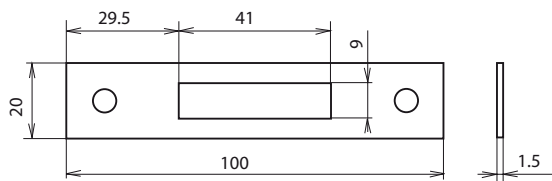

**REF. 10267/2**  
Stainless Steel  
Acier Anoxydable

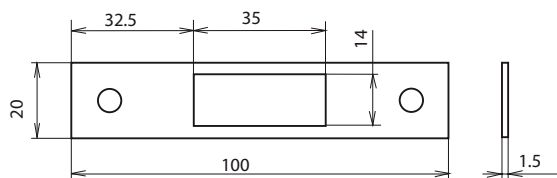

**REF. 10703**  
Aluminium  
Aluminium

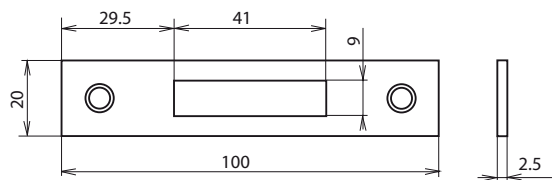

**REF. 10704**  
Aluminium  
Aluminium

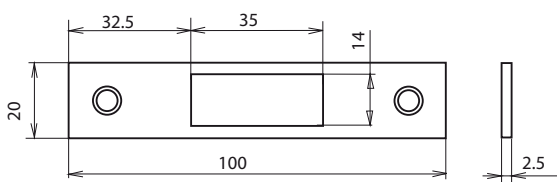

**REF. 10705 - 10705A**  
Stainless Steel  
Acier Anoxydable

	A
<b>10705</b>	23
<b>10705A</b>	20

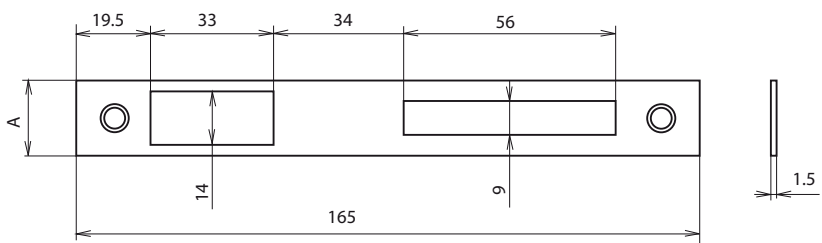

**REF. 10708**  
Stainless Steel  
Acier Anoxydable

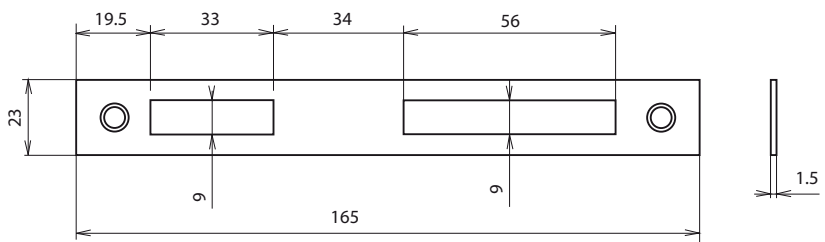

**1.19**

REF.	LOCKS SERRURES
<b>7874/2</b>	7874 (.1)
<b>10267/2</b>	10267 (.1)
<b>10703</b>	7874 (.2 and et .31)
<b>10704</b>	8416 (.6 .31 and et .21) 10267 (.2 and et .31)
<b>10705</b>	9596 (.1 .2 and et .31) 10027 (.1 .2 and et .31) 10493 (.1 .2 and et .31)
<b>10705A</b>	7539 (.1 .2 and et .31)
<b>10708</b>	7540 (.1 .2 and et .31) 9626 (.1 .2 and et .31) 10259 (.2 and et .31) 10498 (.1 .2 and et .31)